



Atelier Saint André Perrin

**Poterie, céramique**

# CATALOGUE *des formes*



4, villa de l'Astrolabe  
75015 Paris - FRANCE

+33 1 47 34 85 91  
contact@ateliersap.com  
www.ateliersap.com

SIRET 309 607 653 00016  
TVA FR 53 309 607 653  
APE 2341 Z

2024



**Jatte**

P.M. D. 19 cm, H. 6 cm  
G.M. D. 21 cm, H. 6,5 cm



**Gobelet**

D. 9 cm, H. 7,5 cm



**Bol "saké"**

D. 6,5 cm, H. 4,5 cm



**Tasse avec pied**

D. 11 cm, H. 6 cm



**Porte savon**

D. 11 cm, H. 2,5 cm

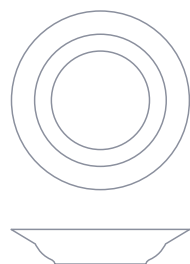

**Porte bouteille**

D. 15 cm, H. 2 cm

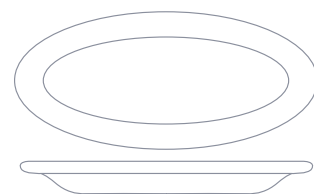

**Ravier ovale à tapas**

17 x 12cm

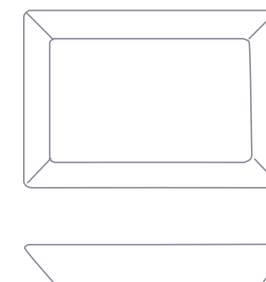

**Ravier**

TGM. 33 x 22 x 2 cm  
GM. 20 x 16 x 2 cm



**Coupelle**

D. 14 cm, H. 5 cm



**Bol sans talon**

<b>G.M.</b>	<b>M.M.</b>	<b>P.M.</b>
D. 14,5 cm	D. 12,5 cm	D. 12 cm

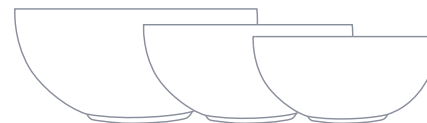

**Bol avec talon**

<b>G.M.</b>	<b>M.M.</b>	<b>P.M.</b>
D. 14,5 cm	D. 12,5 cm	D. 12 cm

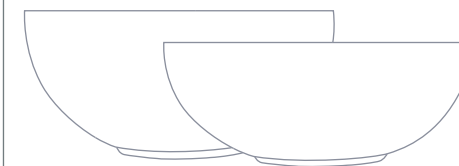

**Bol avec talon**

<b>X.T.G.M.</b>	<b>T.G.M.</b>
D. 17 cm, H. 8 cm	D. 17 cm, H. 7 cm

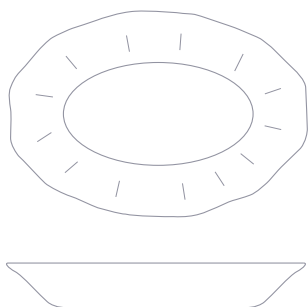

**Tapas à godrons**

16,5 x 12 cm

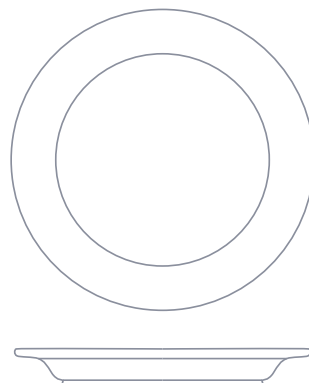

**Assiette de présentation**

D. 31 cm, H. 2,2 cm

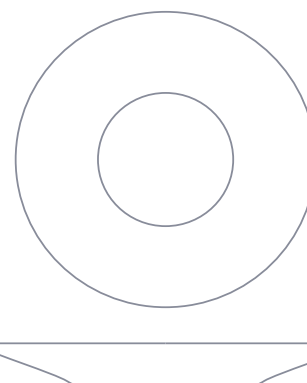

**Assiette de présentation bord large**

D. 29,5 cm, H. 2,5 cm

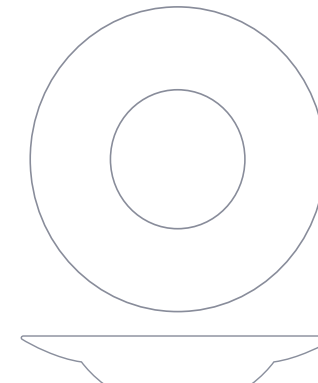

**Assiette de présentation creuse**

D. 24,5 cm, H. 4,5 cm

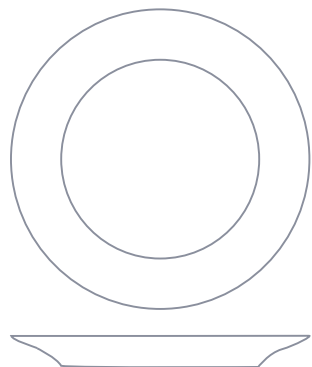

Assiette classique

D. 25 cm, H. 2 cm

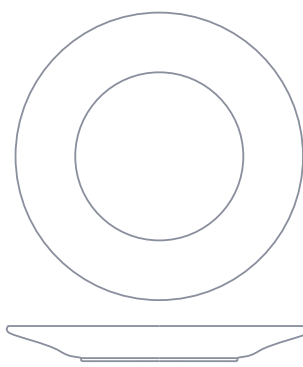

Assiette "Fabrizio"

D. 24 cm, H. 2 cm

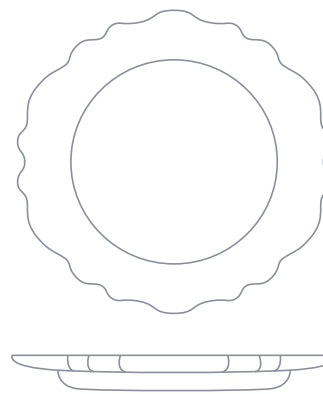

Assiette à Godrons

D. 29 cm, H. 2 cm

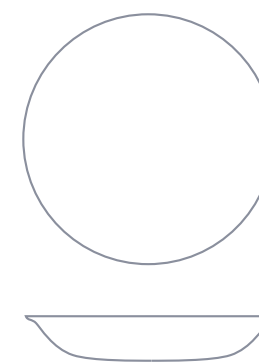

Assiette à soupe

D. 19,5 cm, H. 3 cm

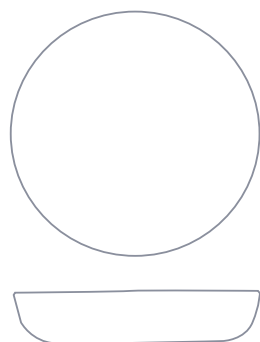

Assiette à bouillie

D. 17 cm, H. 3,5 cm

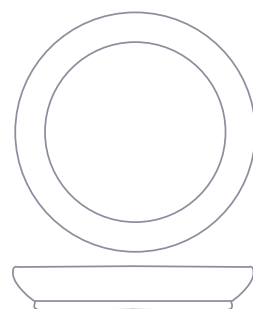

Assiette à dessert

D. 20 cm, H. 2,7 cm

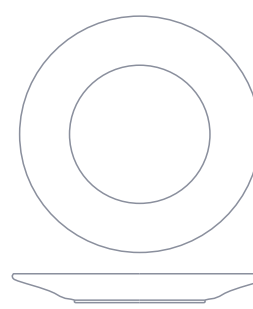

Assiette à dessert "Fabrizio"

D. 19 cm, H. 2 cm

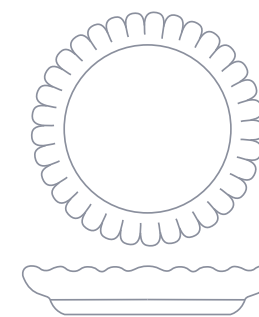

Assiette à dessert XVIIIe

D. 22,5 cm, H. 2,5 cm

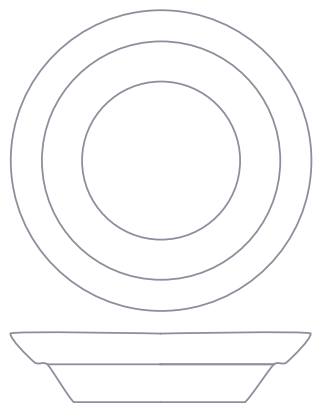

Plat "Mallorca"

D. 30 cm, H. 6,5 cm

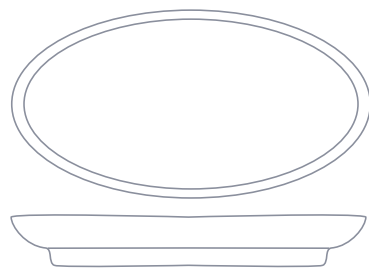

Plat ovale

31 x 18 x 2 cm

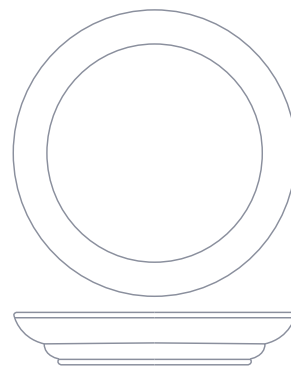

Plat rond

P.M. D. 30 cm, H. 4 cm  
G.M. D. 37 cm

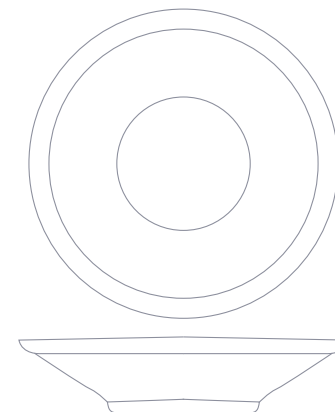

Plat rond très grand modèle

D. 43 cm, H. 7,5 cm

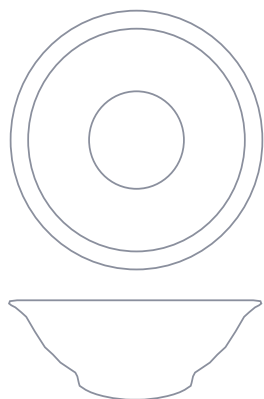

Plat creux rond

D. 19,5 cm, H. 6,5 cm

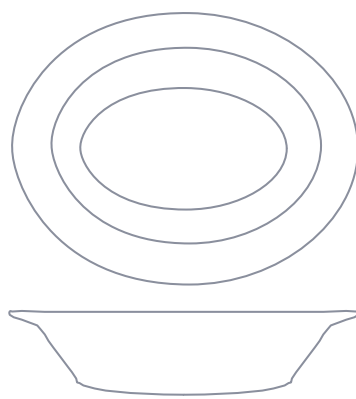

Plat creux ovale

24 x 19 x 5 cm

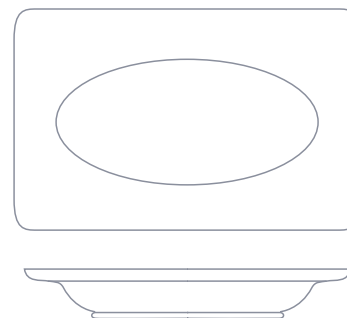

Plat rectangulaire

38 x 24 cm

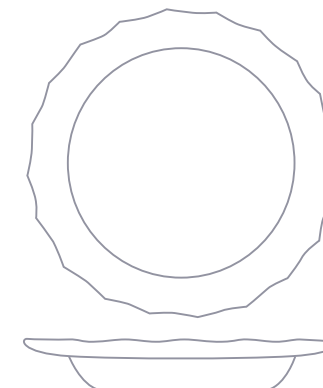

Plat rond grand modèle à godrons

G.M. D. 36,5 cm, H. 4,5 cm

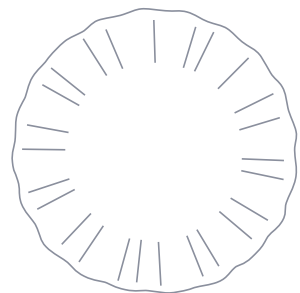

Plat rond à godrons

D. 23 cm, H. 3,5 cm

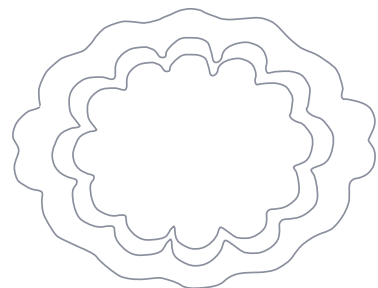

Plats à Oreillettes

P.M. 27 x 15 x 2,5 cm  
G.M. 32,5 x 22 x 2 cm

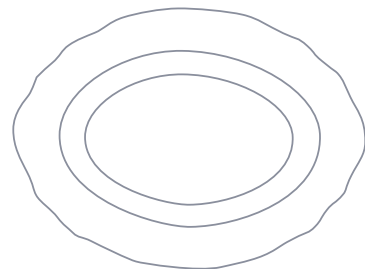

Plat ovale "Moustiers"

32 x 23 x 4 cm

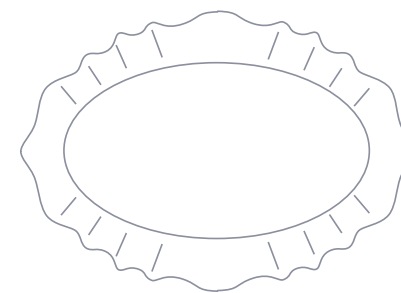

Plat Louis XV

43 x 35 x 4 cm

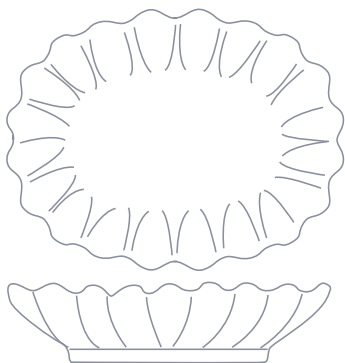

Plat portugais

P.M. 25 x 20 x 5 cm  
G.M. 33 x 27,5 x 6

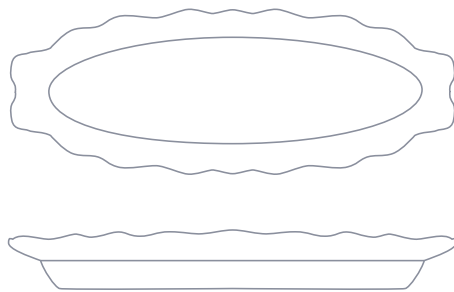

Plat à poisson

52 x 29 x 5 cm

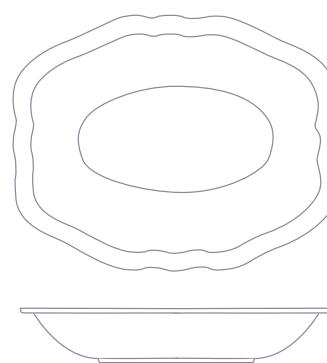

Légumier

26 x 20,5 cm

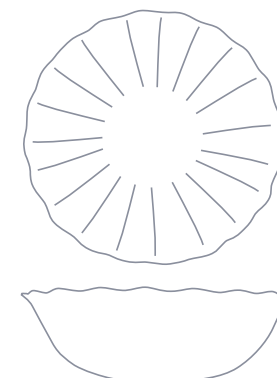

"Charlotte"

D. 24 cm, H. 7 cm

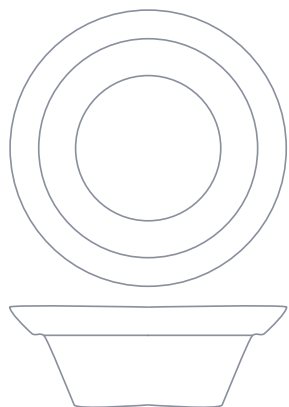

Saladier "Mallorca"

D. 24 cm, H. 11 cm

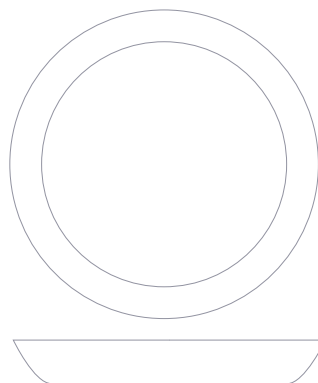

Plat à tarte

D. 27 cm, H. 2,5 cm

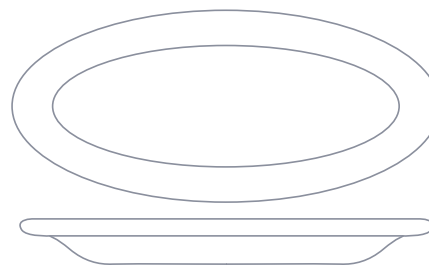

Plat ovale sans talon

P.M. 36,5 x 23,5 x 2 cm  
G.M. 41,5 x 26,5 x 2 cm

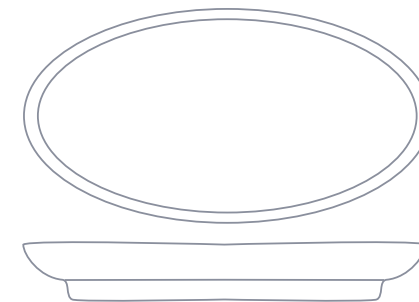

Plat ovale à tapas avec talon

22 x 15,5 x 2,5 cm

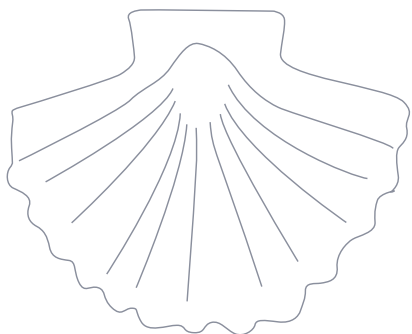

Coquille

32 x 28 x 4 cm

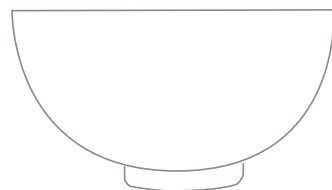

Coupe hémisphérique T4

D. 22 cm, H. 12 cm

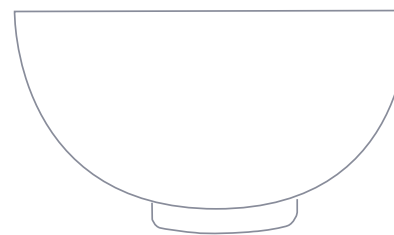

Coupe hémisphérique T5

D. 25 cm, H. 14 cm

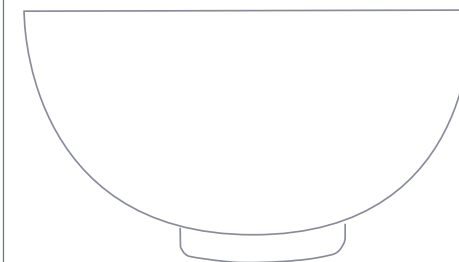

Coupe hémisphérique T6

D. 30 cm, H. 16 cm

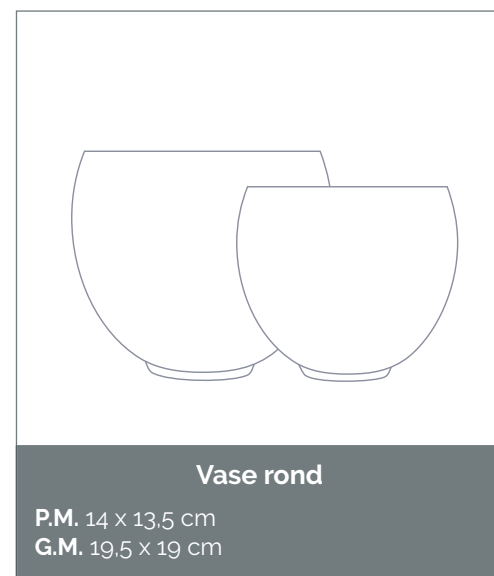
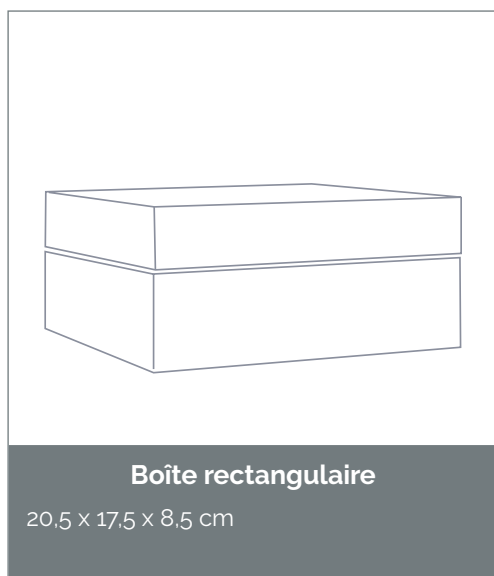
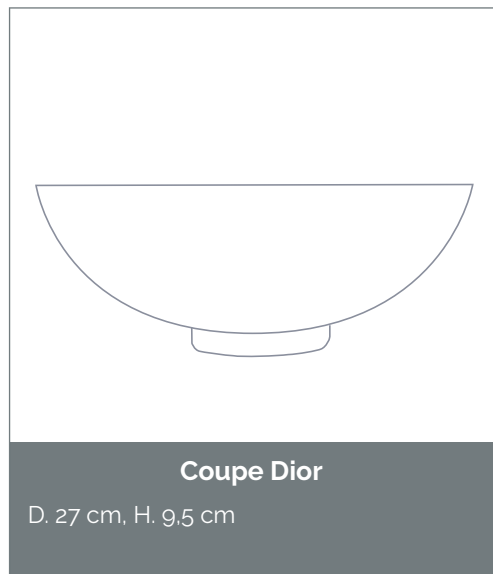
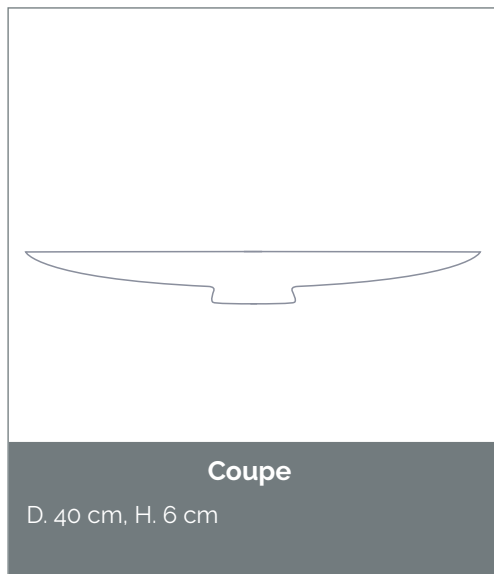



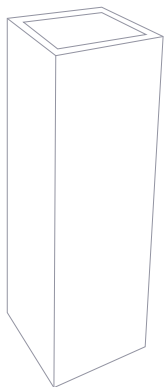

Vase parallélépipède

D. 38 cm, H. 12 cm

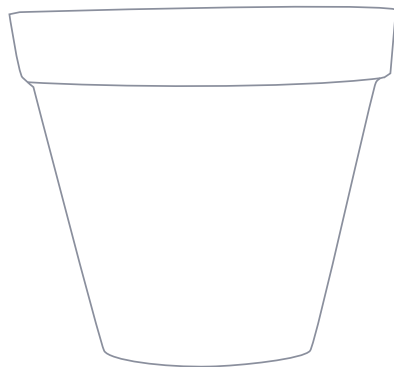

Cache pot

P.M. D. 31,5 cm, H. 27 cm  
G.M. D. 36,5 cm, H. 31,5 cm

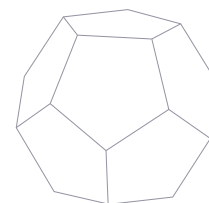

Dodécaèdre

11 cm