



Atelier Saint André Perrin

Poterie, céramique

CATALOG *of shapes*



4, villa de l'Astrolabe
75015 Paris - FRANCE

+33 1 47 34 85 91
contact@ateliersap.com
www.ateliersap.com

SIRET 309 607 653 00016
TVA FR 53 309 607 653
APE 2341 Z

2022



Pasta Bowl

P.M. D. 19 cm, H. 6 cm
G.M. D. 21 cm, H. 6,5 cm



Goblet

D. 9 cm, H. 7,5 cm



Bowl "saké"

D. 6,5 cm, H. 4,5 cm



Cup with talon

D. 11 cm, H. 6 cm



Soap dish

D. 11 cm, H. 2,5 cm

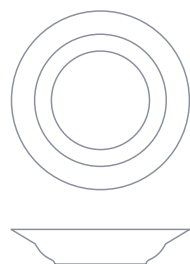

Bottle older

D. 15 cm, H. 2 cm

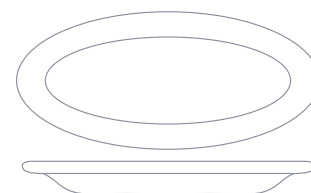

Oval hors d'œuvres dish

17 x 12cm

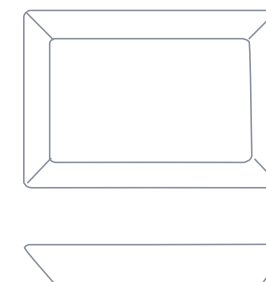

Hors d'œuvres dish

TGM. 33 x 22 x 2 cm
GM. 20 x 16 x 2 cm



Small dish

D. 14 cm, H. 5 cm

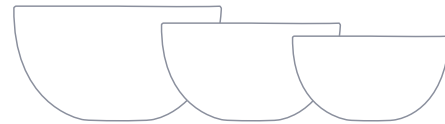

Bowl without talon

G.M.	M.M.	P.M.
D. 14,5 cm	D. 12,5 cm	D. 12 cm

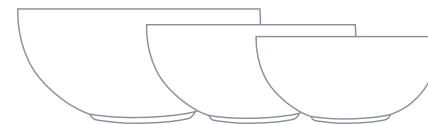

Bowl with talon

G.M.	M.M.	P.M.
D. 14,5 cm	D. 12,5 cm	D. 12 cm

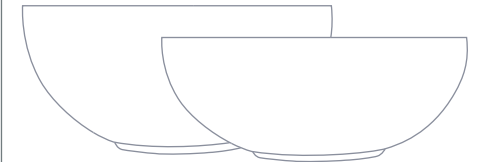

Bowl with talon

X.T.G.M.	T.G.M.
D. 17 cm, H. 8 cm	D. 17 cm, H. 7 cm

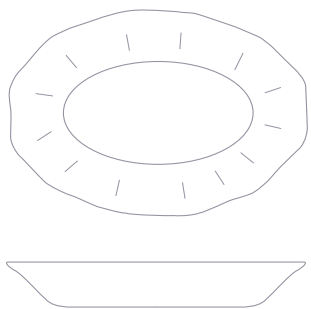

Tapas à godrons

16,5 x 12 cm

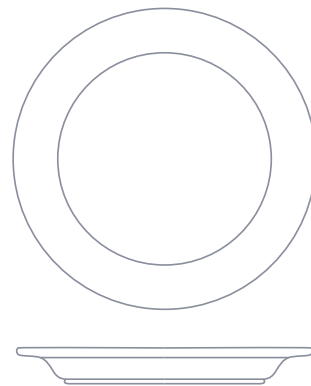

Presentation plate

D. 31 cm, H. 2,2 cm

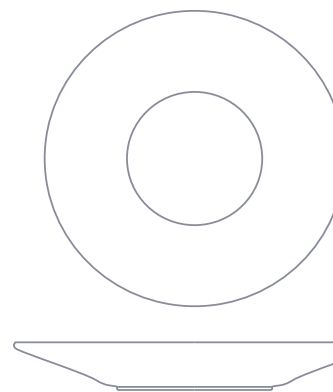

Wide edge presentation plate

D. 29,5 cm, H. 2,5 cm

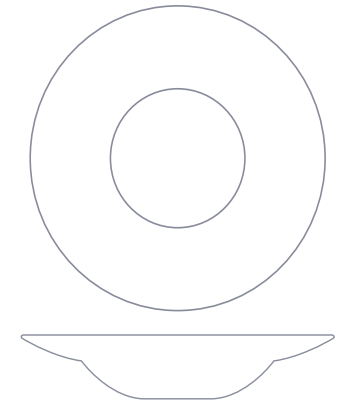

Hollow presentation plate

D. 24,5 cm, H. 4,5 cm

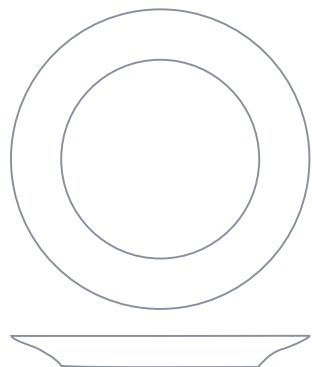

Diner plate

D. 25 cm, H. 2 cm

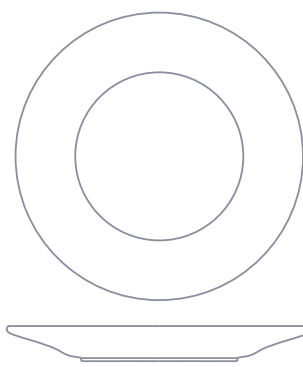

"Fabrizio" plate

D. 24 cm, H. 2 cm

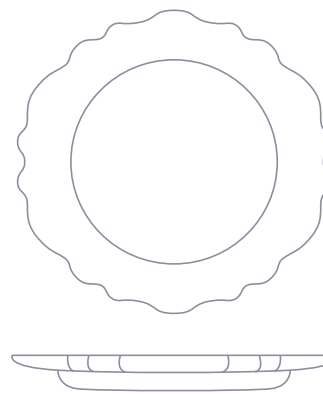

"Godron" plate

D. 29 cm, H. 2 cm

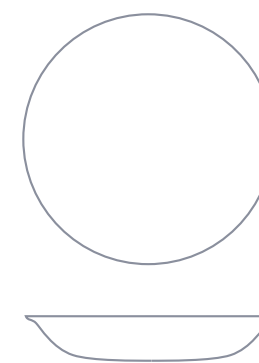

Soup plate

D. 19,5 cm, H. 3 cm

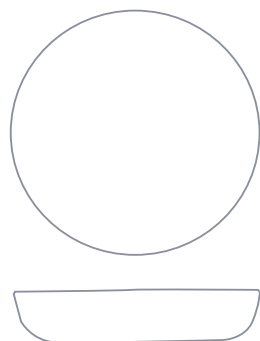

Small soup plate

D. 17 cm, H. 3,5 cm

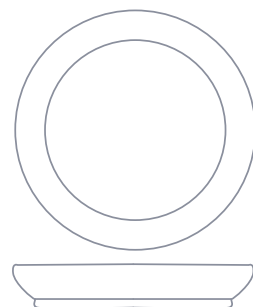

Dessert Plate

D. 20 cm, H. 2,7 cm

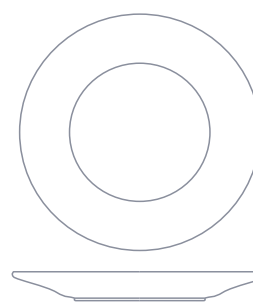

"Fabrizio" dessert Plate

D. 19 cm, H.2 cm

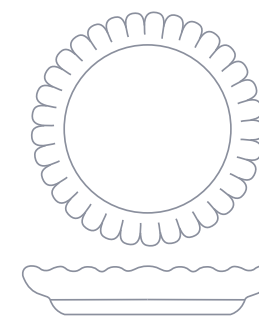

Dessert plate XVIIIe

D. 22,5 cm, H. 2,5 cm

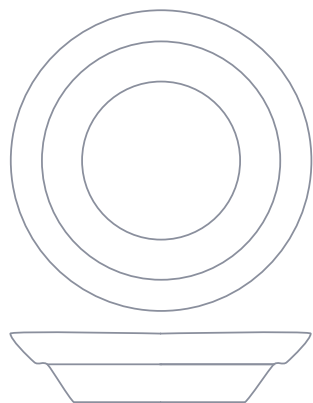

Platter "Mallorca"

D. 30 cm, H. 6,5 cm

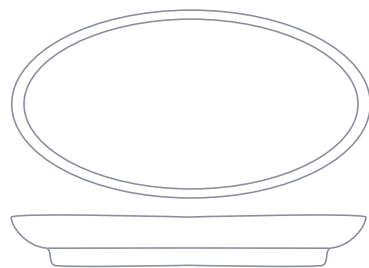

Oval dish

31 x 18 x 2 cm

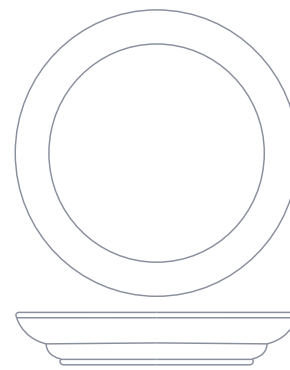

Round dish

P.M. D. 30 cm, H. 4 cm
G.M. D. 37 cm

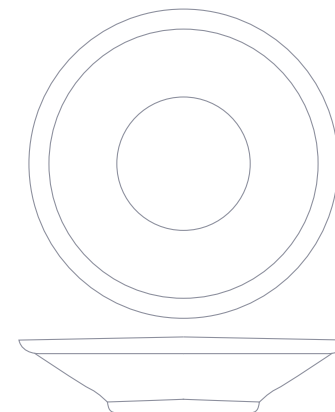

Round dish T.G.M.

D. 43 cm, H. 7,5 cm

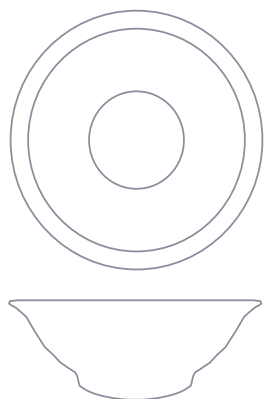

Deep round dish

D. 19,5 cm, H. 6,5 cm

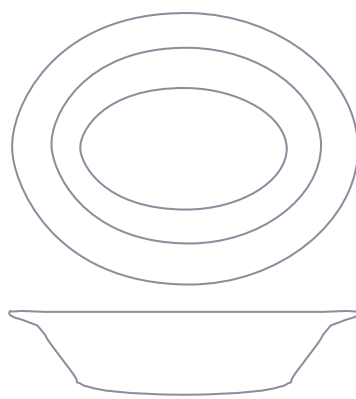

Deep oval dish

24 x 19 x 5 cm

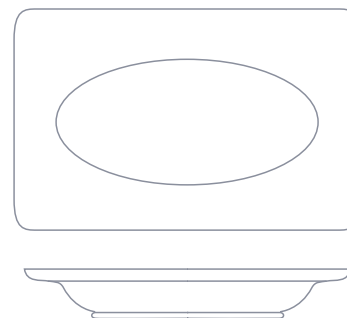

Rectangular dish

38 x 24 cm

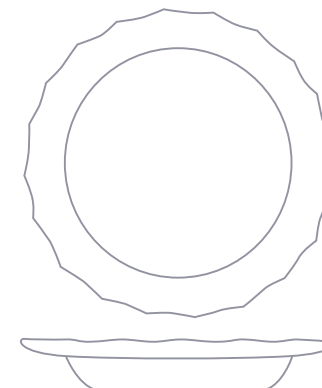

"Godron" Round dish G.M.

G.M. D. 36,5 cm, H. 4,5 cm

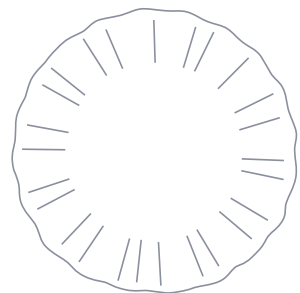

"Godron" Round dish

D. 23 cm, H. 3,5 cm

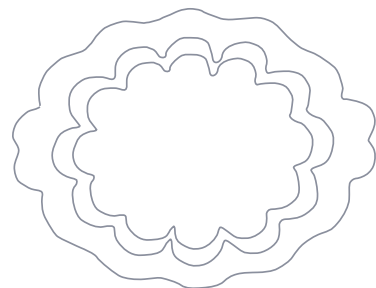

Dish with festoon P.M.

P.M. 27 x 15 x 2,5 cm
G.M. 32,5 x 22 x 2 cm

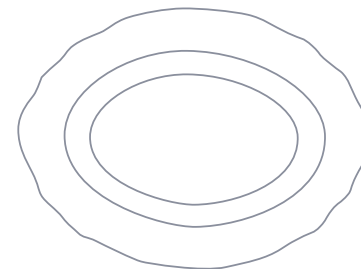

Oval dish "Moustiers"

32 x 23 x 4 cm

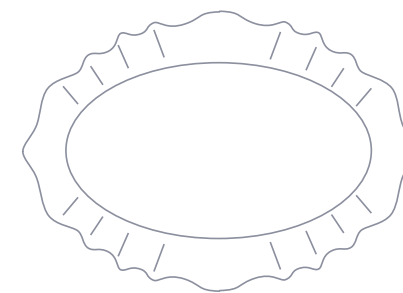

Louis XV dish

43 x 35 x 4 cm

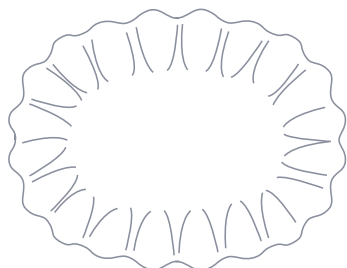

Portuguese dish

P.M. 25 x 20 x 5 cm
G.M. 33 x 27,5 x 6

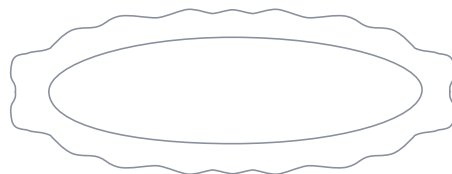

Fish dish

52 x 29 x 5 cm

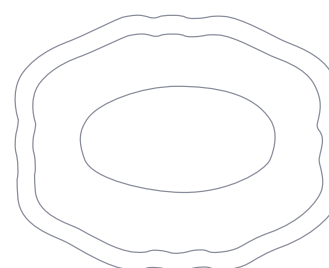

Vegetable dish

26 x 20,5 cm

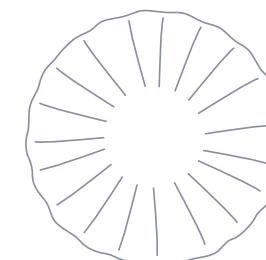

"Charlotte"

D. 24 cm, H. 7 cm

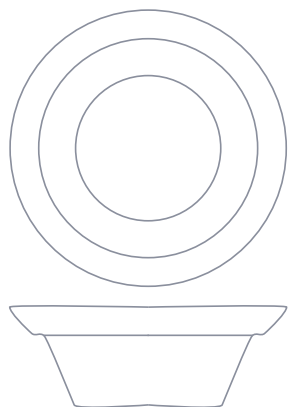

Salad bowl "Mallorca"

D. 24 cm, H. 11 cm

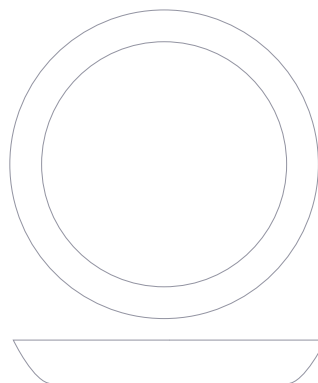

Pie dish

D. 27 cm, H. 2,5 cm

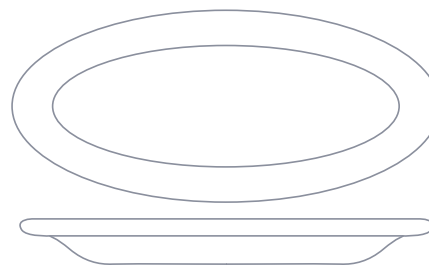

Oval dish without talon

P.M. 36,5 x 23,5 x 2 cm
G.M. 41,5 x 26,5 x 2 cm

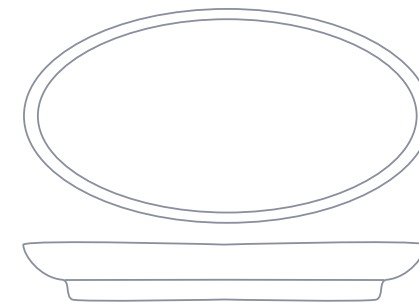

Oval dish with talon "à tapas"

22 x 15,5 x 2,5 cm

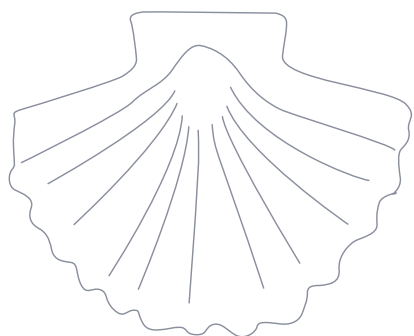

Shell

32 x 28 x 4 cm

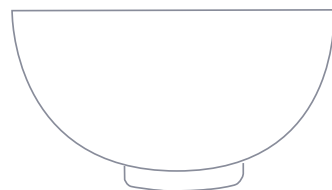

Coupe hémisphérique T4

D. 22 cm, H. 12 cm

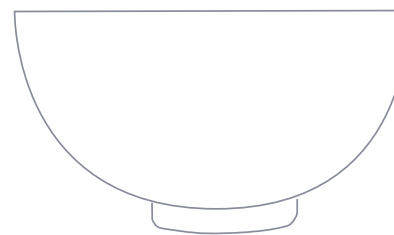

T5 Hemispheric Cup

D. 25 cm, H. 14 cm

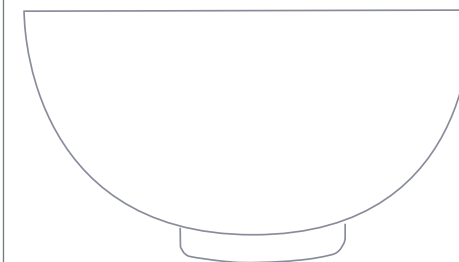

T6 Hemispheric Cup

D. 30 cm, H. 16 cm

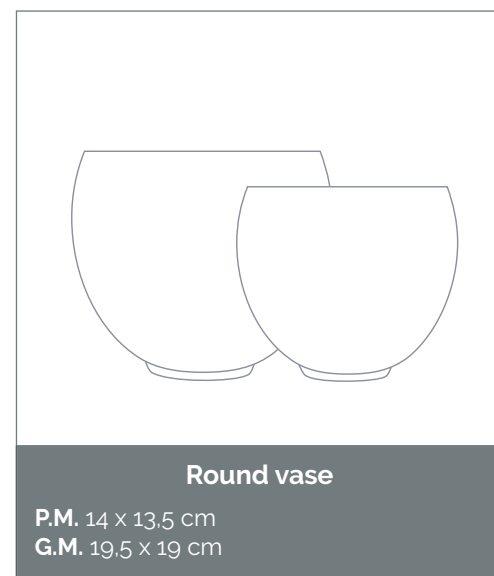
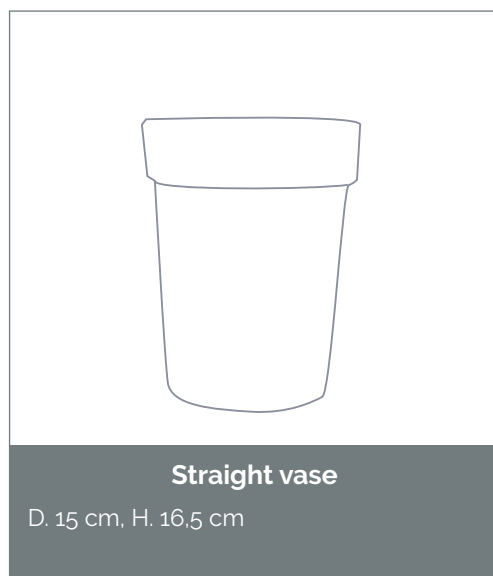
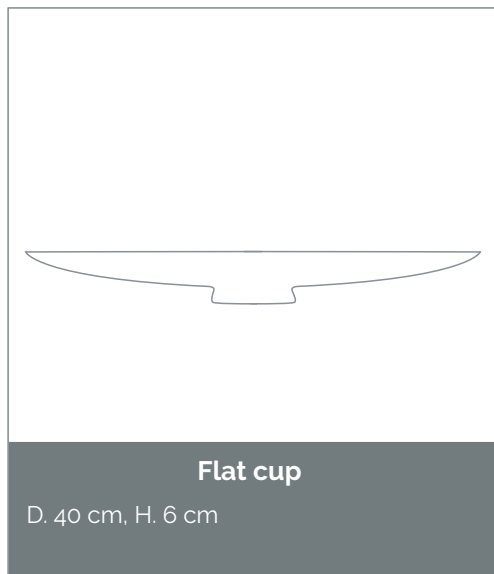

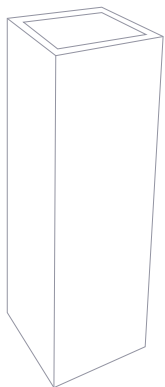

Parallelepiped vase

D. 38 cm, H. 12 cm

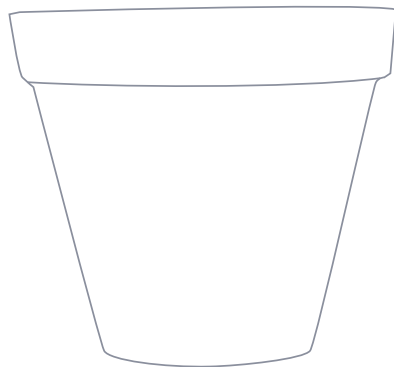

Flower pot holder

P.M. D. 31,5 cm, H. 27 cm
G.M. D. 36,5 cm, H. 31,5 cm

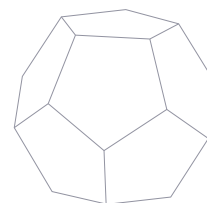

Dodecahedron

11 cm